

rod...e...ive!

ve!

vip
vodafone

A billboard advertisement for Vodafone VIP. It features a woman with blonde hair, wearing a red sleeveless dress, smiling and posing with her arms raised. The background is a light, hazy outdoor scene. The advertisement includes the Vodafone logo and the text 'rod...e...ive!' at the top, 've!' at the bottom left, and 'vip vodafone' in a red box at the bottom right.

ECHARGE!
... ..

A billboard advertisement for ECHARGE!. It features a woman with long dark hair, wearing a blue and white striped shirt and dark pants, sitting on a bench. The background is a light, hazy outdoor scene. The advertisement includes the text 'ECHARGE!' in large letters at the top and '... ..' below it.

**GRAD
PLJEKA**

A sign for the bus shelter. It features a circular logo with a stylized eagle or bird. Below the logo, the text 'GRAD PLJEKA' is written in bold, capital letters. The sign is mounted on a white metal frame.

BUS SHELTERS

Bus shelter 101

Construction

Zincd steel in antracit colour (RAL 7016 or other colour upon request) or stainless steel AISI 304

Cover

Acrylic 4 mm standard white or according to request

Filling

Safety glass 10 mm with aluminium glassholders

Lenght

Modul lenght up to individual requests

Width

Made in 4 types of standard width, custom made possibility

Options

CITY LIGHT advertising, kiosks as part of shelters, toilets, etc.

bus shelter 101 653 stainless steel, 3 modules

equipment:
100 801 CITY LIGHT onesided
100 001 timetable window
100 202 stainless steel bench
100 701 milky safety glass
100 020 bus stop sign plate

bus shelter 101 653 stainless steel, 3 modules

equipment:
100 202 stainless steel bench
100 801 CITY LIGHT onesided
100 001 timetable window
100 700 city logo engraving on glass
litter bin



two bus shelters 101 3 modules side by side, with City Lights and litter bins

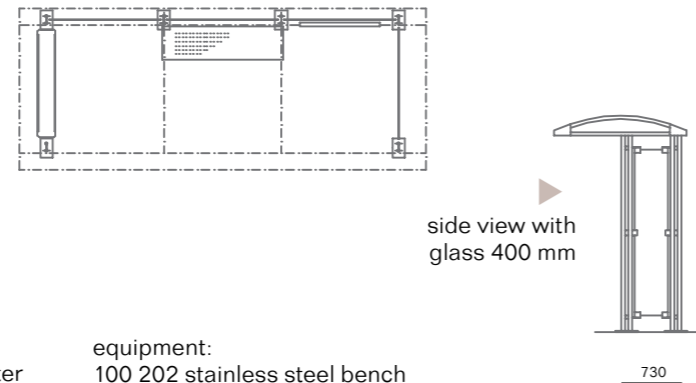
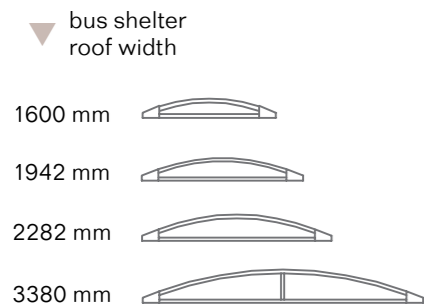
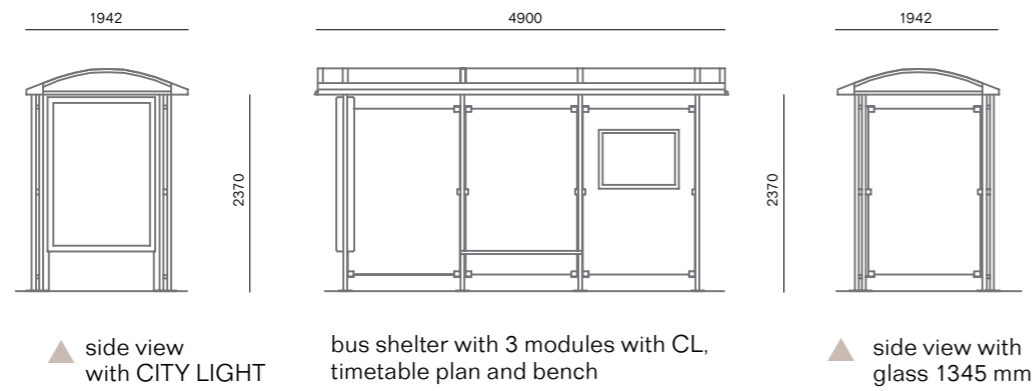

- equipment:
- 100 202 stainless steel bench
 - 100 801 CITY LIGHT onesided
 - 100 802 CITY LIGHT twosided
 - 100 700 city logo engraving on glass
- bus shelter 101 604 stainless steel, 4 modules

Bus shelter 101

construction	roof width	side glass	no. of modules (1 module = 1414 mm)				po zahtjevu
			2	3	4	5	
antracit RAL 7016 or on request	1600 mm	1000 mm	101 002	101 003	101 004	101 005	101 009
		no glass	101 052	101 053	101 054	101 055	101 059
	1942 mm	1345 mm	101 102	101 103	101 104	101 105	101 109
		400 mm	101 152	101 153	101 154	101 155	101 159
	2282 mm	no glass	101 162	101 163	101 164	101 165	101 169
		1345 mm	101 202	101 203	101 204	101 205	101 209
3380 mm	2x 1345 mm	101 302	101 303	101 304	101 305	101 309	
	1000 mm	101 502	101 503	101 504	101 505	101 509	
stainless steel AISI 304	1600 mm	no glass	101 552	101 553	101 554	101 555	101 559
		1345 mm	101 602	101 603	101 604	101 605	101 609
	1942 mm	400 mm	101 652	101 653	101 654	101 655	101 659
		no glass	101 662	101 663	101 664	101 665	101 669
	2282 mm	1345 mm	101 702	101 703	101 704	101 705	101 709
		2 x 1345 mm	101 802	101 803	101 804	101 805	101 809

additional equipment

bench		litter bin	
bench antracit RAL 7016, width 400 mm, lenght 1 module	100 201	see product line ROBUSTUS	
bench s. steel perforated plate width 400 mm, lenght 1 module e	100 202		
timetable window		decoration - personification of safety glass	
aluminium frame and plexiglass, 950 x 710 mm	100 001	safety glass with print	100 700
		milk safety glass (for use near walls etc.)	100 701
CITY LIGHT advertising space 801		decorative - ambiental bus shelter illumination	
CL onesided in bus shelter	100 801	LED bus shelter illumination / fluo / halogen illumination	100 500
CL twosided in bus shelter	100 802		
CL onesided ROTATING in bus shelter	100 803	interactive connection	
CL twosided (one side fixed, other side ROTATING)	100 804	info kiosk - on demand	100 900
CL twosided (both sides ROTATING) in bus shelter	100 805	bus stop sign	
		bus stop sign plate	100 020

- equipment:
- 100 202 two benches stainless steel
 - 100 801 two CITY LIGHTs onesided
 - 100 802 CITY LIGHT twosided
 - 100 001 timetable window
 - 100 700 city logo engraving on glass
- bus shelter 101 608 stainless steel, 8 modules



bus shelter
101 603
stainless steel,
3 modules

equipment:
100 202 stainless steel bench
100 801 x 2 CITY LIGHT twosided
100 700 city logo engraving on glass





▲ bus shelter
101 604
stainless steel
4 modules
with newspaper kiosk
type 2200 width 2 modules

bus shelter equipment:
100 202 stainless steel bench
100 801 CITY LIGHT onesided
100 802 CITY LIGHT twosided
100 700 city logo engraving on glass

Bus shelter 102

Design
EUROmodul Design Studio

Construction
Zincated steel in antracit colour (RAL 7016 or other colour upon request) or stainless steel AISI 304

Cover
Acrylic 4 mm standard white or according to request

Filling
Safety glass 10 mm with aluminium glassholders

Lenght
Modul lenght up to individual requests

Bus shelter 102

construction	no. of modules (1 module = 1465 mm)			
	2	3	4	5
antracit RAL 7016 or on request	102 002	102 003	102 004	102 005
s. steel AISI 304	102 102	102 103	102 104	102 105

additional equipment

bench	
bench antracit RAL 7016, Width 400 mm, lenght 1 module	100 201
stainless steel bench perforated plate, width 400 mm, lenght 1	100 202
timetable window	
aluminium frame and plexiglass, 950 x 710 mm	100 001
CITY LIGHT advertising space 801	
CL onesided in bus shelter	100 801
CL twosided in bus shelter	100 802
CL onesided ROTATING in bus shelter	100 803
CL twosided (one side fixed, other side ROTATING)	100 804
CL twosided (both sides ROTATING) in bus shelter	100 805
litter bin	
see product line ROBUSTUS	
decoration - personification of safety glass	
safety glass with print	100 700
decorative - ambiantal bus shelter illumination	
LED bus shelter illumination / fluo / halogenom rasvjetom na	100 500
interactive connection	
info kiosk - on demand	100 900

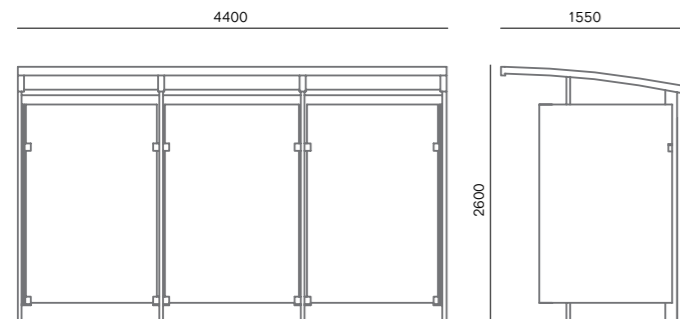

bus shelter 102 103 stainless steel 3 modules
 equipment: 100 202 stainless steel bench 100 001 timetable window litter bin

Bus shelter 103

Construction
Zincated steel pipes

Roof
Polyurethane pannel, white

Filling
Safety glass 8 mmin aluminium profiles

Lenght
Modul lenght up to individual requests

Bus shelter 103

construction	no. of modules (1 module = 2400 mm)		
	1	2	3
zincated steel pipes	103 001	103 002	103 003

additional equipment

bench	
4 pcs. plastic seats	100 203
timetable window	
aluminium frame and plexiglass, 950 x 710 mm	100 001
litter bin	
see product line ROBUSTUS	

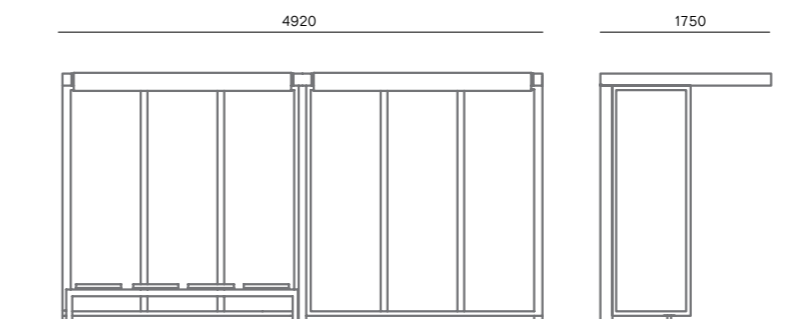

bus shelter 103 002 2 modules
 equipment: 100 203 plastic seats



Bus shelter 104

Design
EUROmodul Design Studio

Construction
Zincated steel in antracit colour (RAL 7016 or other colour upon request) or stainless steel AISI 304

Roof
Safety glass 5+5 mm, milky

Filling
Safety glass 10 mm with aluminium glassholders

Lenght
Modul lenght up to individual requests

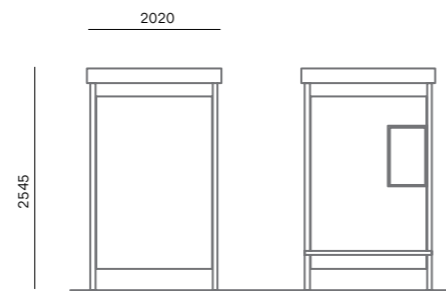
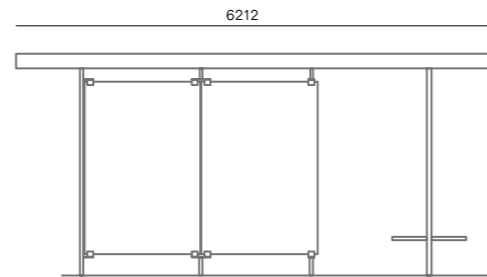
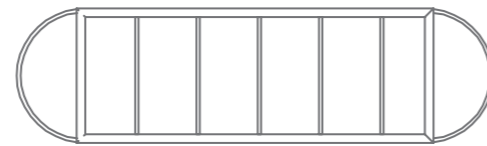

bus shelter
104 103
stainless steel
3 modules

equipment:
100 204 bench
100 002 timetable window
100 802 two CITY LIGHT
vitrines

Bus shelter 104

construction	no. of modules (1 module = 1465 mm)	
	2	3
antracit RAL 7016 or on request	104 002	104 003
stainless steel AISI 304	104 102	104 103

additional equipment

bench	
bench antracit RAL 7016, width 400 mm, lenght 1 module	100 204

timetable window	
aluminium frame and plexiglass, 520 x 1000 mm	100 002

CITY LIGHT advertising space 801	
CL onesided in bus shelter	100 801
CL twosided in bus shelter	100 802
CL onesided ROTATING in bus shelter	100 803
CL twosided (one side fixed, other side ROTATING)	100 804
CL twosided (both sides ROTATING) in bus shelter	100 805

litter bin	
see product line ROBUSTUS	

Bus shelter 104 peron

construction	code
antracit RAL 7016 or on request	104 000
stainless steel AISI 304	104 100

additional equipment

bench	
bench antracit RAL 7016 or according request	100 205

CITY LIGHT advertising space	
CL arched onesided on shelter pillar	100 806

litter bin	
see product line ROBUSTUS	

multipurpose units	
phone booth, bancomat, info kiosk, - see product 954	

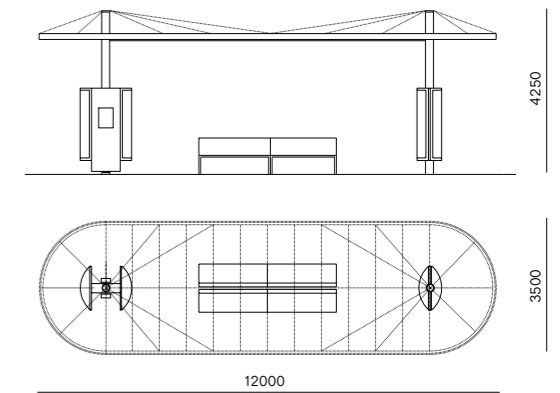

multipurpose unit with two CITY LIGHT spaces and phone booth implemented in shelter column



Bus shelter 107

Design
Šček Cindrić design studio

Construction
Zincated steel in antracit colour (RAL 7016 or other colour upon request) or stainless steel AISI 304

Roof
White poliurethane pannel

Filling
Safety glass 10 mm

Lenght
Modul lenght up to individual requests

additional equipment

bench	
bench antracit RAL 7016, width 400 mm, lenght 1 module	100 201
s. steel bench perforated plate, width 400 mm, lenght 1 module e	100 202

timetable window	
aluminium frame and plexiglass, 950 x 710 mm	100 001

CITY LIGHT advertising space 801	
CL onesided in bus shelter	100 801
CL twosided in bus shelter	100 802
CL onesided ROTATING in bus shelter	100 803
CL twosided (one side fixed, other side ROTATING)	100 804
CL twosided (both sides ROTATING) in bus shelter	100 805

litter bin	
see product line ROBUSTUS	

decoration - personification of safety glass	
safety glass with print	100 700

decorative - ambiantal bus shelter illumination	
LED bus shelter illumination / fluo / halogen illumination	100 500

interactive connection	
info kiosk - on demand	100 900

LED bus shelter illumination
100 500



Bus shelter 107

construction	no. of modules (1 module = 1435 mm)			
	2	3	4	5
antracit RAL 7016 or on request	107 002	107 003	107 004	107 005
s. steel AISI 304	107 102	107 103	107 104	107 105

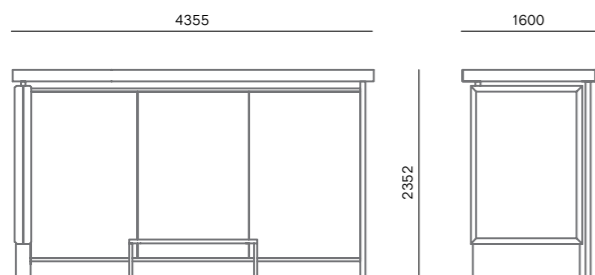

Bus shelter 106

Construction
Zincated steel in antracit colour (RAL 7016 or other colour upon request) or stainless steel AISI 304

Roof
Twosided, acrylic 4 mm standard white or according to request

Filling
Safety glass 8 mmin aluminium profiles

Bus shelter 106

construction	code
antracit RAL 7016 or on request	106 001

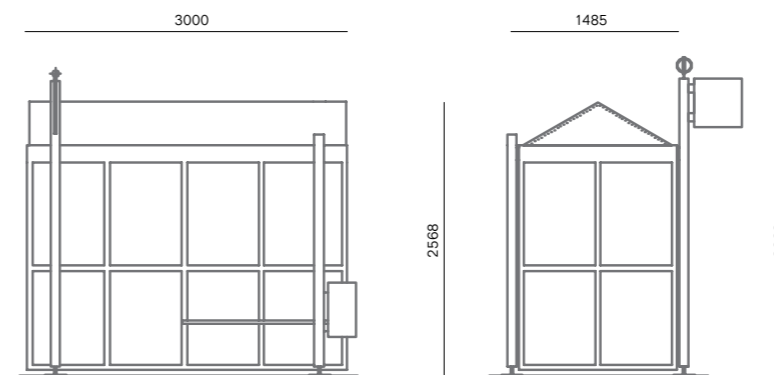

equipment:
100 205 bench
100 401 bus stop sign
litter bin

bus shelter
106 001



Bus shelter 111

Design

EUROmodul Design Studio

Construction

Zincated steel in antracit colour (RAL 7016 or other colour upon request) or stainless steel AISI 304

Cover

Acrylic 4 mm white transparent or according request

Filling

Safety glass 10 mm with aluminium glassholders

Lenght

Modul lenght up to individual requests

Bus shelter 111

construction	no. of modules (1 module = _____ mm)			
	2	3	4	5
antracit RAL 7016 or on request	111 002	111 003	111 004	111 005
s. steel AISI 304	111 102	111 103	111 104	111 105

additional equipment

bench		
bench antracit RAL 7016, width 400 mm, lenght 1 module		100 201
s. steel bench perforated plate, width 400 mm, lenght 1 module		100 202
timetable window		
aluminium frame and plexiglass, 950 x 710 mm		100 001
CITY LIGHT advertising space 801		
CL onesided in bus shelter		100 801
CL twosided in bus shelter		100 802
CL onesided ROTATING in bus shelter		100 803
CL twosided (one side fixed, other side ROTATING)		100 804
CL twosided (both sides ROTATING) in bus shelter		100 805

litter bin		
see product line ROBUSTUS		
decoration - personification of safety glass		
safety glass with print		100 700
decorative - ambiantal bus shelter illumination		
LED bus shelter illumination / fluo / halogenom rasvjetom na		100 500
interractive connection		
info kiosk - on demand		100 900

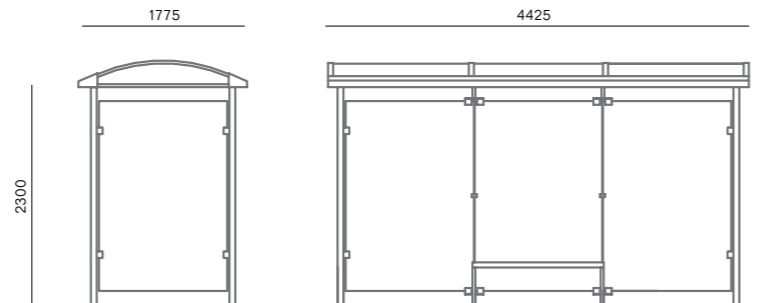

detalj spoja glass staklodržaćima



▼ bus shelter 111 103 3 modules, stainless steel

equipment: 100 202 stainless steel bench 100 001 timetable window 100 700 glass print

▲ bus shelter 111 103 3 modules, stainless steel

equipment: 100 202 stainless steel bench 100 001 timetable window 100 802 City Light twosided 100 700 glass print



Bus shelter 120 AETERNA

Design
EUROmodul Design Studio

Construction
Zincd steel in antracit colour (RAL 7016 or other colour upon request) or stainless steel AISI 304

Filling
Safety glass 10 mm with aluminium glassholders

Roof
Safety glass, laminated 6 + 6 mm with milk foil

Bus shelter 120 AETERNA

construction	no. of modules (1 module = 1310 mm)			
	2	3	4	5
antracit RAL 7016 or on request	120 002	120 003	120 004	120 005
s. steel AISI 304	120 102	120 103	120 104	120 105

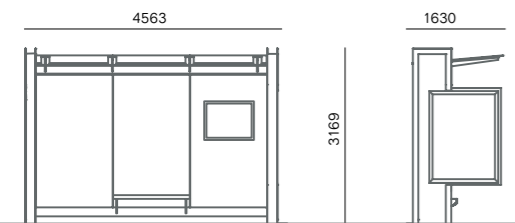

additional equipment

bench	
bench antracit RAL 7016, Width 400 mm, lenght 1 module	100 201
s. steel bench perforated plate, width 400 mm, lenght 1 module	100 202

timetable window	
aluminium frame and plexiglass, 950 x 710 mm	100 001

CITY LIGHT advertising space 801	
CL onesided in bus shelter	100 801
CL twosided in bus shelter	100 802
CL onesided ROTATING in bus shelter	100 803
CL twosided (one side fixed, other side ROTATING)	100 804
CL twosided (both sides ROTATING) in bus shelter	100 805

litter bin	
on request	

decoration - personification of safety glass	
safety glass with print	100 700
glassholders - spyders - of side glass	100 750

decorative - ambiantal bus shelter illumination	
LED bus shelter illumination / fluo / halogen illumination	100 500

interactive connection	
info kiosk - on demand	100 900

Bus shelter 122

Design
EUROmodul Design Studio

Construction
Zincd steel in antracit colour (RAL 7016 or other colour upon request) or stainless steel AISI 304

Filling
Safety glass 10 mm with aluminium glassholders

Roof
Safety glass, laminated 6 + 6 mm with milk foil and HPL laminates

Bus shelter 122

construction	no. of modules (1 module = 1445 mm)			
	2	3	4	5
antracit RAL 7016 or on request	122 002	122 003	122 004	122 005
s. steel AISI 304	122 102	122 103	122 104	122 105

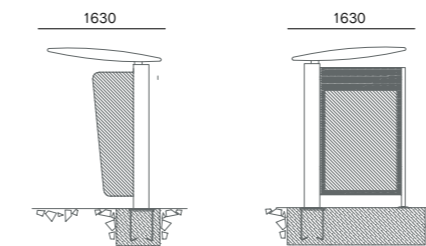

additional equipment

bench	
bench antracit RAL 7016, Width 400 mm, lenght 1 module	100 201
s. steel bench perforated plate, width 400 mm, lenght 1 module	100 202

timetable window	
aluminium frame and plexiglass, 950 x 710 mm	100 001

CITY LIGHT advertising space 801	
CL onesided in bus shelter	100 801
CL twosided in bus shelter	100 802
CL onesided ROTATING in bus shelter	100 803
CL twosided (one side fixed, other side ROTATING)	100 804
CL twosided (both sides ROTATING) in bus shelter	100 805

litter bin	
on request	

decoration - personification of safety glass	
safety glass with print	100 700
glassholders - spyders - of side glass	100 750

decorative - ambiantal bus shelter illumination	
LED bus shelter illumination / fluo / halogen illumination	100 500

interactive connection	
info kiosk - on demand	100 900



Bus shelter 122 103 adopted to urban city center environment



Bus shelter 123

Design
EUROmodul Design Studio

Lenght
Modul lenght up to individual requests

Construction
Zincd steel in antracit colour (RAL 7016 or other colour upon request) or stainless steel AISI 304

Roof
Safetly glass, laminated 6 + 6 mm with milk foil and HPL laminates

additional equipment

bench	
bench antracit RAL 7016, Width 400 mm, lenght 1 module	100 201
s. steel bench perforated plate, width 400 mm, lenght 1 module	100 202

timetable window	
aluminium frame and plexiglass, 950 x 710 mm	100 001

CITY LIGHT advertising space 801	
CL onesided in bus shelter	100 801
CL twosided in bus shelter	100 802
CL onesided ROTATING in bus shelter	100 803
CL twosided (one side fixed, other side ROTATING)	100 804
CL twosided (both sides ROTATING) in bus shelter	100 805

litter bin	
on request	

decoration - personification of safety glass	
safety glass with print	100 700
glassholders - spyders - of side glass	100 750

interractive connection	
info kiosk - on demand	100 900

Bus shelter 123

construction	no. of modules (1 module = 1345 mm)			
	2	3	4	5
antracit RAL 7016 or on request	123 002	123 003	123 004	123 005
s. steel AISI 304	123 102	123 103	123 104	123 105

bus shelter 123 103
3 modules, stainless steel



bus shelter 123 003
3 modules, antracit colour

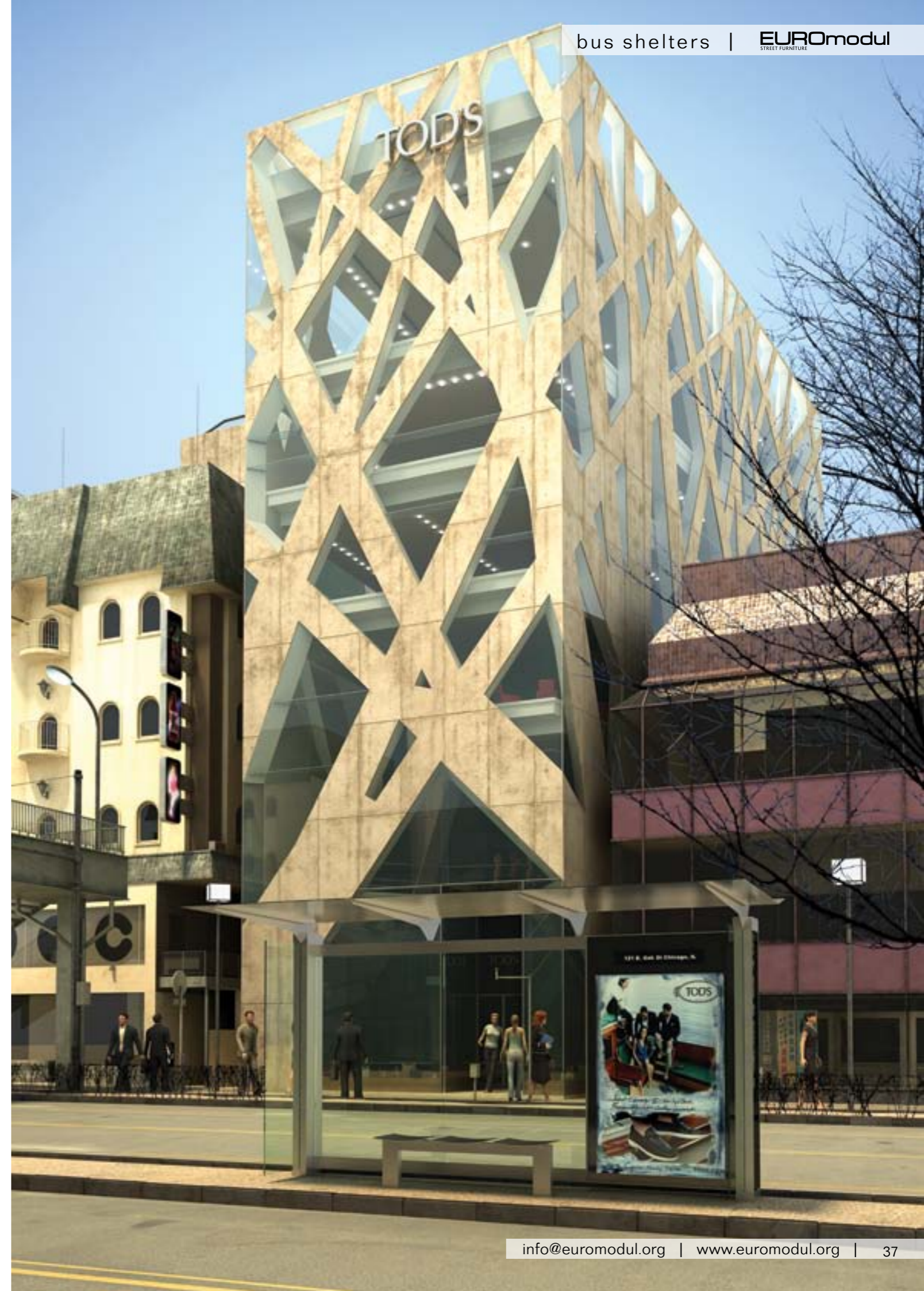

Bus shelter 119

Design

EUROmodul Design Studio

Construction

Zincated steel in antracit colour (RAL 7016 or other colour upon request) or stainless steel AISI 304

Roof

Safety glass, laminated
6 + 6 mm with milk foil

Filling

Safety glass 10 mm with aluminium glassholders

Lenght

Modul lenght up to individual requests

additional equipment

bench

bench antracit RAL 7016, Width 400 mm, lenght 1 module	100 201
stainless steel bench perforated plate, width 400 mm, lenght 1	100 202

timetable window

aluminium frame and plexiglass, 950 x 710 mm	100 001
--	---------

CITY LIGHT advertising space 801

CL onesided in bus shelter	100 801
CL twosided in bus shelter	100 802
CL onesided ROTATING in bus shelter	100 803
CL twosided (one side fixed, other side ROTATING)	100 804
CL twosided (both sides ROTATING) in bus shelter	100 805

litter bin

on request

side glass

cinčani plastificirani lim umjestno bočnog glass	100 710
laminate in colour or wood design umjesto bočnih stakala	100 711

Bus shelter 119

construction	roof	no. of modules (1 module = 1345 mm)			standard jumbo 5,0 x 2,4 m
		2	3	4	
antracit RAL 7016 or on request	safety glass, laminated	119 002	119 003	119 004	119 008
	zincated and plasticated plate	119 102	119 103	119 104	119 108
	laminate in colour or wood design	119 202	119 203	119 204	119 208
stainless steel AISI 304	safety glass, laminated	119 302	119 303	119 304	119 308
	zincated and plasticated plate	119 402	119 403	119 404	119 408
	laminate in colour or wood design	119 502	119 503	119 504	119 508



bus shelter
119 308
3 modules
antracit colour,
roof from safety glass,
laminated,
standard jumbo
placate 5,0 x 2,4 m